

OS2



OS2 | abstract from the general catalogue

Secco Sistemi is an Italian trademark leader in the production of systems for doors, windows and facades in galvanized steel, stainless steel corten steel and brass.

Every year, 2 million linear metres of profile bars are used to produce 200.000 doors and windows.

Secco Sistemi boasts 60 years of experience and constant commitment dedicated to achieve high quality and innovation for their products.



OS2

an innovative door
and window frame
system with minimal
bulk for sustainable
architecture

OS2 system has been studied, designed and made by Secco Sistemi in order to provide historical and monumental buildings with door and window frames that could visually recall those used from mid 19th to mid 20th century (the typical iron windows). Thanks to its smaller sections and the use of materials like stainless steel, **OS2** system is perfect for the need of contemporary architecture.

OS2 system combines in one product the need to integrate those architectural aspects and to meet current regulations in terms of energy saving, living comfort and sustainability of products and processes used.

OS2 system is equipped with a 47 mm lateral and a 62 mm central section, made with thermal break profiles - integrated with a complete range of system accessories - allowing for a wide range of openings.



areas of application

- doors
- windows



- glazing bead
- fitting groove for glazing up to 40 mm thick
- internal and external rebate
- internal rebate seal
- frame with weep system seal
- composite structural thermal break
- polyurethane
- polyamide
- stainless steel version

OS2

for the designer:
a flexible system that
guarantees the best
solution for the facade

OS2 is an extremely simple, ample and flexible system for the designer that cares for details. It encompasses 37 different profiles and three sub-systems and thus allows for an accurate design of the facade of the building through the articulate use of the shadows of its openings. The glass windows become integral part of the architecture, with their choice of flush or non-flush windows and visible or invisible openings. **OS2** uses minimised sections with profiles ranging from 27 to 62 mm.

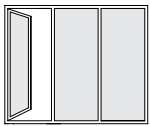

47/62 mm

minimised sections
non-flush glasses
visible openings on the facade

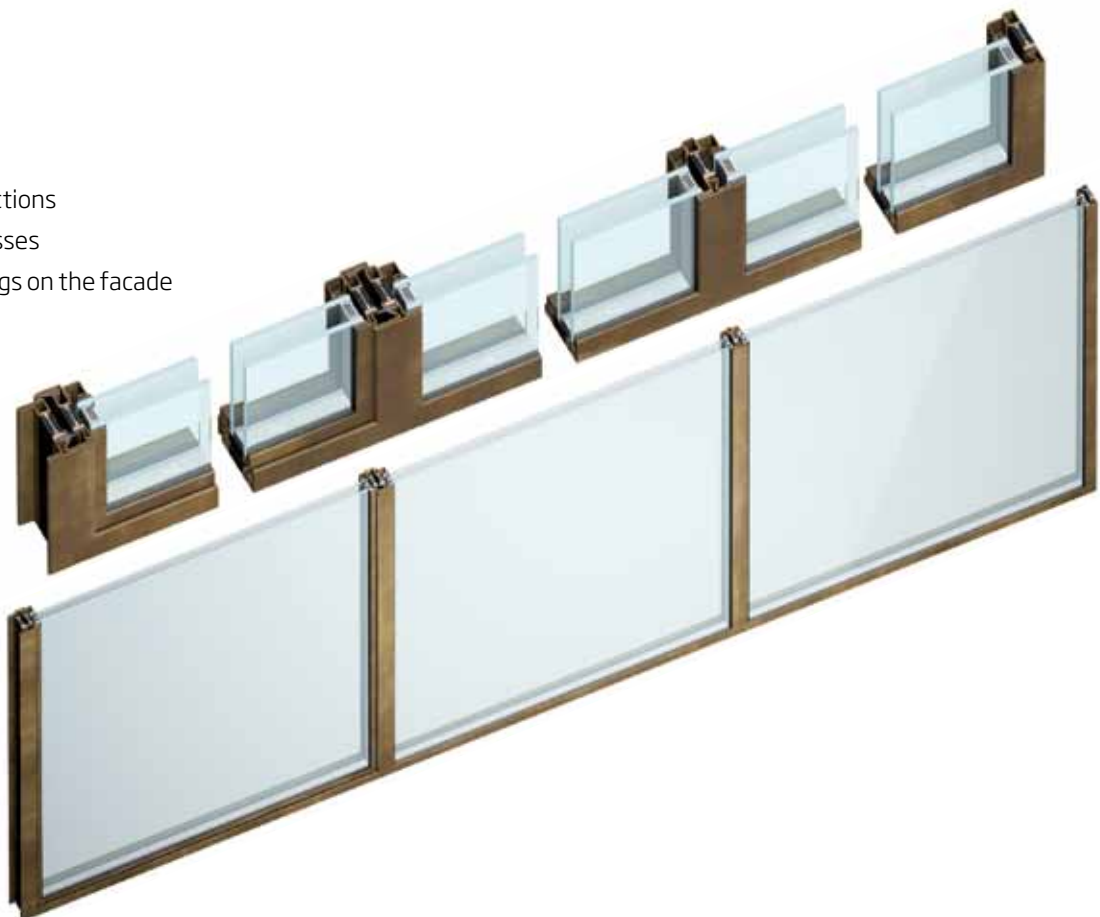

external view, internal opening

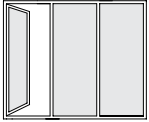

42/62 mm

minimised sections
flush glasses
visible openings on the facade



external view, internal opening

windows
and doors with
thermal break

facade
and cladding

safe and fireproof
windows
and doors

steel
windows
and doors

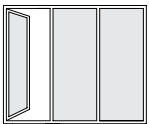

62/62 mm

congruent sections
flush glasses
invisible openings on the facade

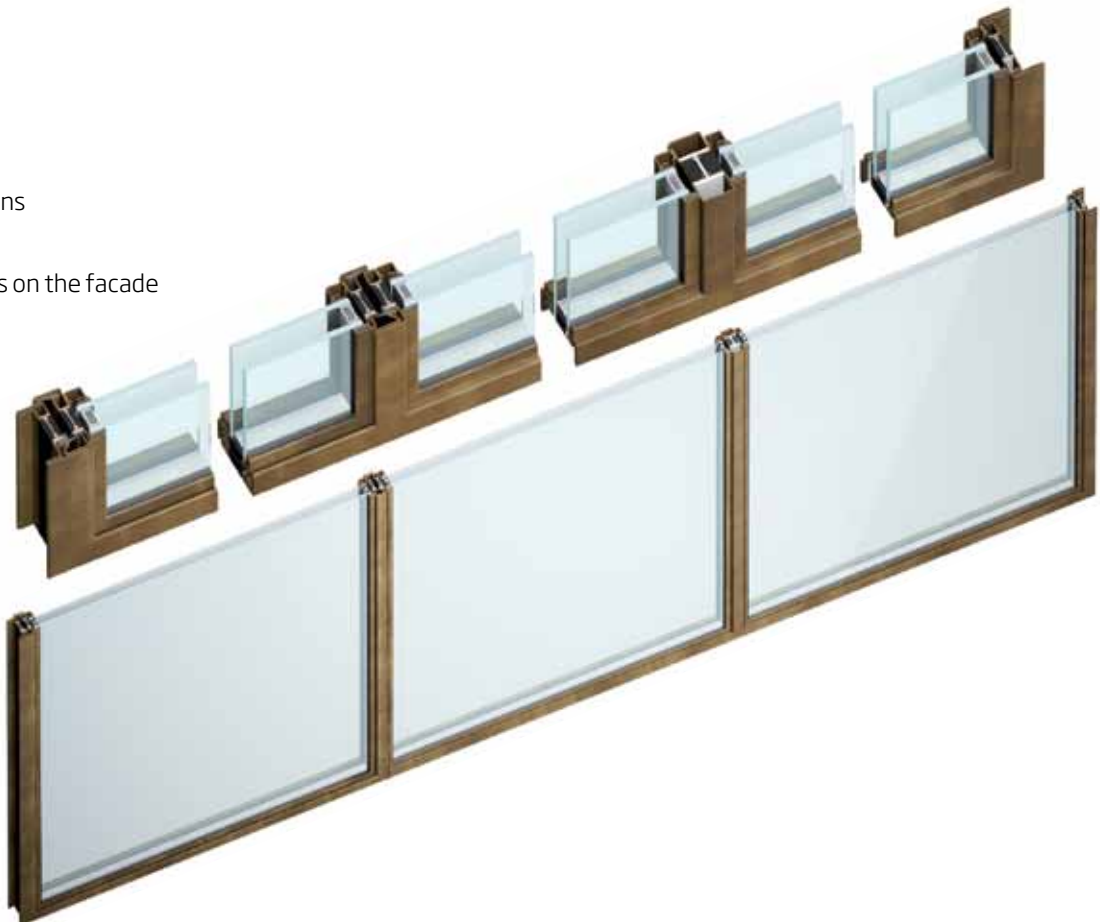

external view, internal opening

13th century palace | Venice



The palace is located in Dorsoduro, Venice, and it's made of two overlapping rooms plus yard representing a typical example of minor architecture of the 13th century. The restoration and redevelopment project was mainly aimed at the layout of the building, in order to ensure an articulated yet easy and modern usage of it.

The restoration works have occurred at different stages but were still closely linked one to another: the architectural and artistic restoration of the valuable finishes, on one side, and the functional adaptation of the spaces, on the other. With this view in mind, the stairs were reshaped as an overall vertical link unit to enhance the spacial "feeling".



windows and doors with thermal break

facade and cladding

safe and fireproof windows and doors

steel windows and doors

The important architectural context has required a particular care in the choice of the finishes and accessories. It was decided to follow the local building tradition (use of the stone, seamless floors, Venetian plaster, metal) while respecting the current building and

fitting innovations. OT67 burnished brass OS2 door and window frame system was chosen. This particular system, in fact, combines the slenderness of its profiles with the elegance and sturdiness of the material. On top of this, it fits perfectly into the Venetian historical and unique setting.

OS2

for the designer:
different types
of glazing beads
for a wide choice
of details

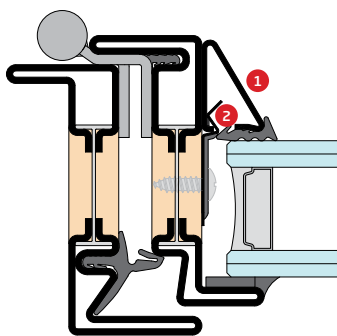

1. glazing bead
2. glazing bead mounting clips

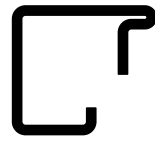

straight square glazing bead



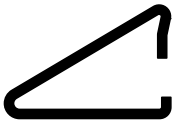

triangular glazing bead

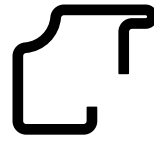

rounded square glazing bead



windows
and doors with
thermal break

facade
and cladding

safe and fireproof
windows
and doors

steel
windows
and doors

Gallerie Dell'Accademia | Venice



The monumental complex of the Gallerie Dell'Accademia stands in the site once occupied by the big complex formed by the church of Santa Maria della Carità, the nunnery of Canonici Lateranensi and the Scuola Grande di Santa Maria Della Carità.

From the 16th century until the second half of the 1940s, several architects worked on the complex of the Gallerie: Palladio, Gianantonio, Selva, up to Carlo Scarpa who was in charge of an important, although partial, recovery intervention.



windows
and doors with
thermal break

facade
and cladding

safe and fireproof
windows
and doors

steel
windows
and doors

The renovation aimed at expanding the space for exhibitions in the vast and articulated museum and it has required a delicate yet significant intervention by the designer under the strict and competent supervision of the Soprintendenza ai Beni Architettonici (Superintendence for Architectural Heritage). The requirements for door and window frames were very precise: minimal visual impact, high thermal and acoustic performance, low

maintenance and, finally, the use of a material that would fit with the architectural context. For this reason, OS2 door and window frames in burnished brass were used. These not only fully meet the initial restoration requirements but also have a high resistance to corrosion, which is a vital requirement in a difficult and aggressive marine environment like the one in Venice.

OS2 window inward opening

system and performance



OS2 inward opening window is an integrated system with accessories, seals and thermal break profiles 65 mm deep allowing for a wide range of windows, rectangular, shaped or curved. They can be equipped with double glazing up to 40 mm thick. Each solution is equipped with a related set of accessories integrated in the system.

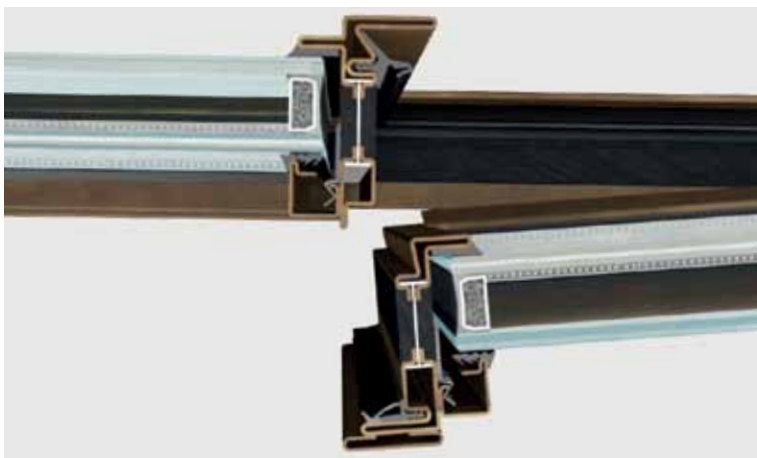

The sealing of the door and window frames is guaranteed by a weep system with central sealing gasket and internal rebate seal. The performance of OS2 thermally insulated system has been tested by the best European certifying labs under the reference standard EN 14351-1.

wind resistance - test pressure	4
wind resistance - frame bending	C
water tightness	8A
acoustic performance (with R_w per IGU 42dB)	43 (-1;-4) dB
thermal transmittance (with U_g glass 1.0 W/m ² K)	1,60 W/m ² K *
air permeability	4

maximum achievable performance

size and variations

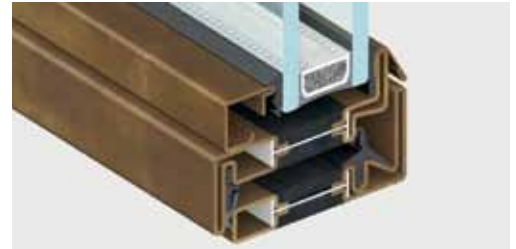

lower section | frame section 47 mm



lateral section | frame section 47 mm



central section | frame section 62 mm



muntin | frame section 36 mm

OS2 is a rebated system with 47 mm face lateral sections and 62 mm central section. For frames with multiple lights a 36mm thermal break profile is used.

materials



galvanized steel



stainless steel

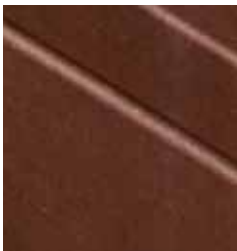

corten steel

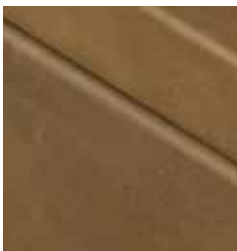

brass

OS2 is available in galvanised steel - in a wide range of colours and superficial finishes in AISI 316L polished or Scotch-Brite stainless steel, corten steel and in brass (OT67 copper alloy).

glazing bead



squared



grooved



triangular

Squared, grooved and triangular: the wide range of glazing beads allows for a variety of different design for your internal window light. the great choice available visually recalls the traditional "iron window" profiles.

vitruvio handles



"small" cut round
h.116 | d.12 mm



"small" sphere round
h.116 | d.12 mm



"small" cut square
h.116 | d.12 mm



"kids"
h.116 | d.15 mm



"oval"
h.80 | l.30 mm

hinges



weld-on hinge
h.60/80/116 mm
d.10 /13/16 mm



two-wing hinge
h.81 | d.12 mm



three-wing hinge
h.90 | d.15 mm

Two and three-wing hinges are adjustable and are supplied in galvanized steel, stainless steel, burnished stainless steel and corten steel. weld-on hinges are in galvanized steel. The following models are adjustable: h.80|d.13mm and h.116|d.16mm.

Handles are available in paintable raw, burnished, chrome polished and polished brass: the medium cut square version is provided also in corten steel.

main type



1



2



3



2



2

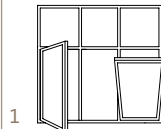

1

3



2

Custom solutions are available in co-operation with Secco Sistemi technical office.

**Maximum wing size
Maximum wing weight**

1. w.1000 | h.2700
100 kg
2. w.2000 | h.2700
100 kg
3. w.1300 | h.800
40 kg

windows and doors with thermal break

facade and cladding

safe and fireproof windows and doors

steel windows and doors

OS2

Siemensstadt | Berlin



The district called Siemensstadt in Berlin was built between 1929 and 1931 on a 19-acre area and it was intended as a residential area for the employees of Siemens factories. It's one of the most famous experimental development ever realised in Germany during the 20s and it's a clear evidence of the research and ideals of

German Rationalism. A team of architects (Scharoun, Häring, Forbat, Henning, Bartning) took part in its realisation, under the lead of Gropius. The building are modern but still designed with the traditional load bearing walls technology. In these building the "full" parts prevail on the "empty" ones, which are conceived merely as horizontal holes; the series of

continuous and parallel balconies develop on the building front. On July 7th, 2008 the district has been listed in the UNESCO World Heritage list.



windows and doors with thermal break

facade and cladding

safe and fireproof windows and doors



steel windows and doors

During the restoration work of this district, which has recently started, the replacement of doors and windows has been the object of a specific evaluation by the designers. The old iron windows needed to be replaced with new window systems that could guarantee not only living comfort, but also the preservation of the previous design and size while guaranteeing, at the same

time, the performance of a modern window system in terms of thermal and acoustic insulation and resistance to weather conditions. OS2 in painted galvanized steel could fulfil all the above requirements and was the ideal choice also for the bigger elements where the reduced size of the sections was balanced by the higher structural resistance of the steel.

Thanks to the thermal break and OS2 gasket system, it was possible to achieve those standards of thermal and acoustic insulation required by the project. (On top of this, the thermal break, the double rebate seals, the frame with weep system and the ironware with multi-point locking system have guaranteed the internal living standard required by the project).

OS2 door inward opening

system and performance



OS2 inward opening door is an integrated system with accessories, seals and thermal break profiles 65 mm deep allowing for a wide range of windows, rectangular, shaped or curved. They can be equipped with double glazing up to 40 mm thick. The sealing of the door and window frames is guaranteed by a weep system with central sealing gasket, a three-side internal rebate seal and an automatic retractable seal.

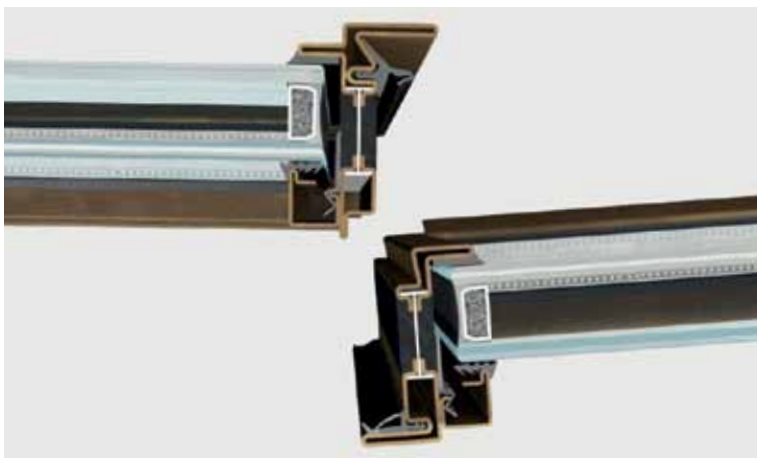

Each solution is equipped with a related set of accessories integrated in the system. The performance of OS2 thermally insulated system has been tested by the best European certifying labs under the reference standard EN 14351-1.

wind resistance - test pressure	1
wind resistance - frame bending	C
water tightness	1A
thermal transmittance (with Ug glass 1.0 W/m ² K)	1,48 W/m ² K*
air permeability	2

maximum achievable performance

size and variations



lateral section | frame section 47 mm



central section | frame section 62 mm

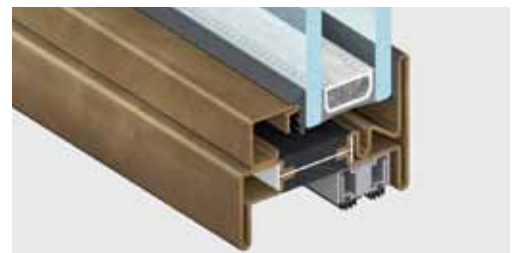

bottom rail | frame section 47 mm



muntin | frame section 36 mm

OS2 is a rebated system with 47 mm face lateral sections and 62 mm central section. For frames with multiple lights a 36mm thermal break profile is used.

materials



galvanized steel



stainless steel

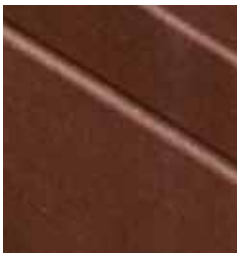

corten steel

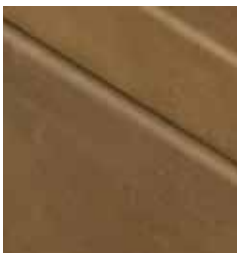

brass

OS2 is available in galvanized steel - in a wide range of colours and superficial finishes in AISI 316L polished or Scotch-Brite stainless steel, corten steel and in brass (OT67 copper alloy).

glazing bead



squared



grooved



triangular

Squared, grooved and triangular: the wide range of glazing beads allows for a variety of different design for your internal window light. the great choice available visually recalls the traditional "iron window" profiles.

vitruvio handles



"medium" cut round
h.116 | d.15 mm



"medium" sphere round
h.116 | d.15 mm



"medium" cut square
h.116 | d.15 mm

Handles are available in paintable raw, burnished, chrome polished and polished brass: the medium cut square version is provided also in corten steel.

hinges



weld-on hinge
h.60/80/116 mm
d.10 /13/16 mm



three-wing hinge
h.90 | d.15 mm

Three-wing hinges are adjustable and are supplied in galvanized steel, stainless steel, burnished stainless steel and corten steel. Weld-on hinges are in galvanized steel: the following models are adjustable: h.80 | d.13mm and h.116 | d.16mm.

main type

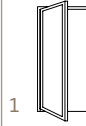

1

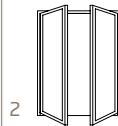

2



2



2

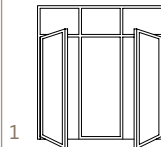

1

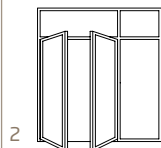

2

Custom solutions are available in co-operation with Secco Sistemi technical office.

**Maximum wing size
Maximum wing weight**

1. w.1000 | h.2700
100 kg
2. w.2000 | h.2700
100 kg

windows and doors with thermal break

facade and cladding

safe and fireproof windows and doors

steel windows and doors

OS2

Privathaus | Bonn



Located close to the historical centre of Bonn, this new residence is faced on the one hand with the private park in which it is set, on the other with the local

traditional architecture, characterised by buildings in exposed brick work with wide glass walls using very thin sightlines in order to better capture the sunlight.



windows
and doors with
thermal break

facade
and cladding

safe and fireproof
windows
and doors



steel
windows
and doors

The use of the OS2 system made of painted galvanized steel is essential for this type of project where a

slim profile is needed but at the same time guaranteeing, high thermal performance and acoustic insulation.

OS2 window outward opening

system and performance



OS2 outward opening window is an integrated system with accessories, seals and thermal break profiles 65 mm deep allowing for a wide range of windows, rectangular, shaped or curved. They can be equipped with double glazing up to 30 mm thick. Each solution is equipped with a related set of accessories integrated in the system.

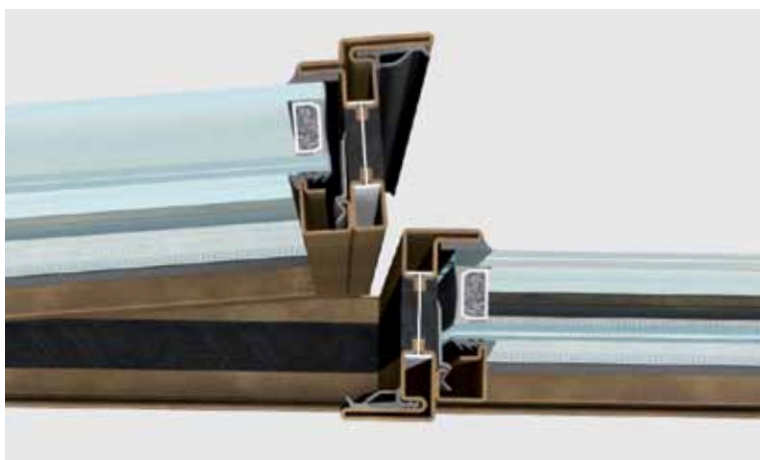

The sealing of the door and window frames is guaranteed by a double rebate seal system. The performance of OS2 thermally insulated system has been tested by the best European certifying labs under the reference standard EN 14351-1.

wind resistance - test pressure	4
wind resistance - frame bending	C
water tightness	8A
thermal transmittance (with U _g glass 1.0 W/m ² K)	1,60 W/m ² K *
air permeability	3

maximum achievable performance

size and variations



lower section | frame section 47 mm



lateral section | frame section 47 mm



central section | frame section 62 mm



muntin | frame section 36 mm

OS2 is a rebated system with 47 mm face lateral sections and 47/62 mm central section. For sashes with multiple lights a 36mm thermal break profile is used.

materials



galvanized steel



stainless steel

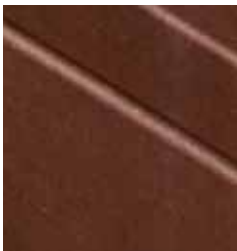

corten steel

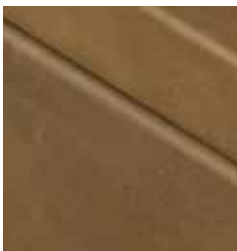

brass

OS2 is available in galvanized steel - in a wide range of colours and superficial finishes in AISI 316L polished or Scotch-Brite stainless steel, corten steel and in brass (OT67 copper alloy).

glazing bead



squared



grooved



triangular

Squared, grooved and triangular: the wide range of glazing beads allows for a variety of different design for your internal window light. the great choice available visually recalls the traditional "iron window" profiles.

handles



"vitruvio small" cut round
h.116 | d.12 mm



"vitruvio small" sphere round
h.116 | d.12 mm



"vitruvio small" cut square
h.116 | d.12 mm



"vitruvio oval"
h.80 | l.30 mm



pulling handle
h.50 mm

hinges



weld-on hinge
h.60/80/116 mm
d.10 /13/16 mm



two-wing hinge
h.81 | d.12 mm



three-wing hinge
h.90 | d.15 mm



pivot system
w.80

Two and three-wing hinges are adjustable and are supplied in galvanized steel, stainless steel, burnished stainless steel and corten steel. weld-on hinges are in galvanized steel. The following models are adjustable: h.80|d.13mm and h.116|d.16mm.

Handles are available in paintable raw, burnished, chrome polished and polished brass: the small cut square version is provided also in corten steel. "vitruvio" small is made in both "T" and "L" version.

main type



1



2



3



2



2

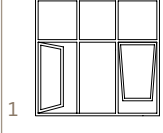

1

3



2

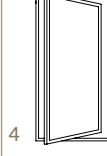

4

Custom solutions are available in co-operation with Secco Sistemi technical office.

Maximum wing size
Maximum wing weight

1. w.1000 | h.2700
100 kg
2. w.2000 | h.2700
100 kg
3. w.800 | h.1300
60 kg
4. w.1000 | h.2700
80 kg

windows and doors with thermal break

facade and cladding

safe and fireproof windows and doors

steel windows and doors

OS2

Sonoma County | California



The villa is nestled harmoniously among the gentle hills of California, among vineyards and olive groves, thanks to the simplicity of the architectural language adopted and the choice of materials and finishes such as stone, wood and recycled metal doors and windows.

The desire to build relationships with the surrounding nature determines the design solutions. On the one hand, geometric volumes are hidden from view by vigorous tall trees, the other large windows projecting the interior into the landscape.



windows
and doors with
thermal break

facade
and cladding

safe and fireproof
windows
and doors



steel
windows
and doors

The use of thin profiles of the OS2 system in painted galvanized steel assures rigorous and essential partitions of windows that frame the landscape at any time of the day.

OS2 door outward opening

system and performance



OS2 outward opening door is an integrated system with accessories, seals and thermal break profiles 65 mm deep allowing for a wide range of windows, rectangular, shaped or curved. They can be equipped with double glazing up to 30 mm thick. The sealing of the door and window frames is guaranteed by a double rebate seal system and an automatic retractable seal.

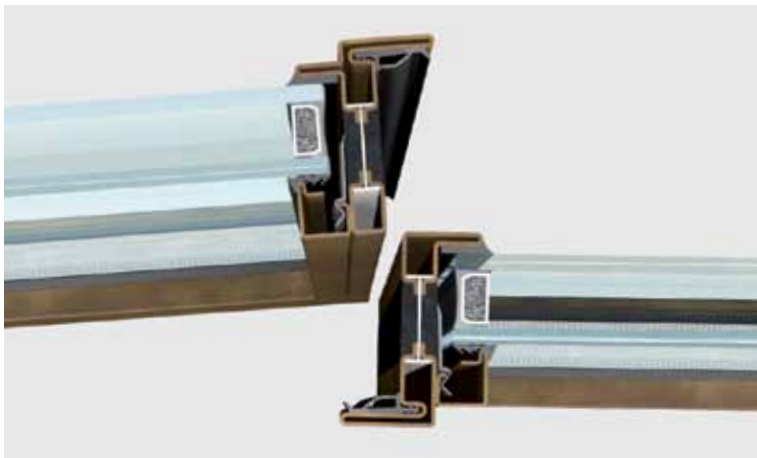

Each solution is equipped with a related set of accessories integrated in the system. The performance of OS2 thermally insulated system has been tested by the best European certifying labs under the reference standard EN 14351-1.

wind resistance - test pressure	1
wind resistance - frame bending	C
water tightness	1A
thermal transmittance (with Ug glass 1.0 W/m²K)	1,48 W/m²K*
air permeability	2

maximum achievable performance

size and variations



lateral section | frame section 47 mm



central section | frame section 62 mm



bottom rail | frame section 54 mm



muntin | frame section 36 mm

OS2 is a rebated system with 47 mm face lateral sections and 62 mm central section. For sashes with multiple lights a 36mm thermal break profile is used.

materials



galvanized steel



stainless steel

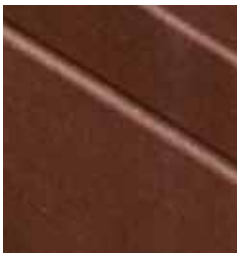

corten steel

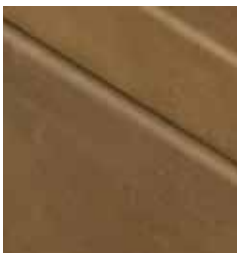

brass

OS2 is available in galvanised steel - in a wide range of colours and superficial finishes - in AISI 304 brushed stainless steel, in AISI 316L polished or Scotch-Brite stainless steel, corten steel and in brass (OT67 copper alloy).

glazing bead



squared



grooved



triangular

Squared, grooved and triangular: the wide range of glazing beads allows for a variety of different design for your internal window light. the great choice available visually recalls the traditional "iron window" profiles.

handles



"vitruvio medium" cut round
h.116 | d.15 mm



"vitruvio medium" sphere round
h.116 | d.15 mm



"vitruvio medium" cut square
h.116 | d.15 mm

Handles are available in paintable raw, burnished, chrome polished and polished brass: the medium cut square version is provided also in corten steel.

hinges



weld-on hinge
h.60/80/116 mm
d.10 /13/16 mm



three-wing hinge
h.90 | d.15 mm

Two and three-wing hinges are adjustable and are supplied in galvanized steel, stainless steel, burnished stainless steel and corten steel. Weld-on hinges are in galvanized steel. The following models are adjustable: h.80|d.13mm and h.116|d.16mm.

main type



1



2

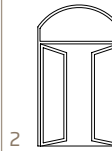

2



2

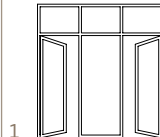

1

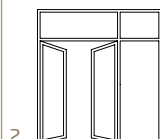

2

Custom solutions are available in co-operation with Secco Sistemi technical office.

Maximum wing size
Maximum wing weight

1. w.1000 | h.2700
100 kg
2. w.2000 | h.2700
100 kg

windows and doors with thermal break

facade and cladding

safe and fireproof windows and doors

steel windows and doors

Prestigious residence in Salviatino | Fiesole (FI)



This building in "Liberty" style is located just outside Florence, at the foot of the hills around Fiesole. It was built in 1909 as an innovative hospital. It became later an aid centre for unmarried women and, afterwards, a hospital for children. It was abandoned in ruin until the late 90s.

In 2002 it was bought by an important real estate company, specialised in the recovery of prestigious buildings, and turned into a luxurious residence with 13 apartments.



windows
and doors with
thermal break

facade
and cladding

safe and fireproof
windows
and doors

steel
windows
and doors

The designers have carried out a radical conservative and artistic restoration while maintaining, at the same time, the charm of the original design and demanding, for the new project, the highest quality for internal and external finishes. Special care was paid to the external door and

window frames in order to try and make the rooms as bright as possible. Thin OS2 profiles in painted steel were used to this end, making it possible to define the large windows - 160 x 360 cm - while maintaining their original design. The use of OS2 thermal break system has allowed

for high thermal insulation performance and great acoustic comfort, the last one being particularly appreciated in this context. It's clear, from the pictures, the difference in dimensions between the new metal door and window frames and the restored wooden ones on the lower level.

designing together

the Secco Sistemi
team works with
the designer,
with enthusiasm
and competence,
looking for
the right solution.
Its work is our
main strength

- alongside those who design
to shape solutions that are
customised and tailored;
- alongside those who design
to support the development
of the technical-operational
process and the cost estimates
- alongside those who design
to provide consultancy
and constant update
on the current regulations
- alongside those who design
to identify the most suitable
window and door frames provider
to carry out the project
- alongside those who design
to assist to the entire project
development and final work,
from the manufacturing
to the final set-up

OS2 inward opening

main sections

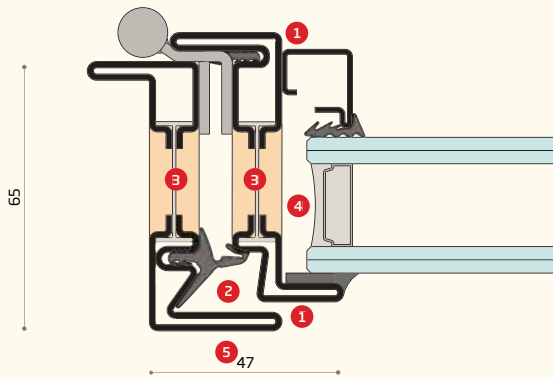

1. internal and external rebate
2. frame with weep system and double gasket
3. structural thermal break in polyamide and polyurethane
4. fitting groove for glazing up to 40 mm thick
5. section with reduced size

profiles

P.2801

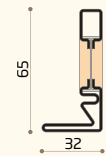

P.2803

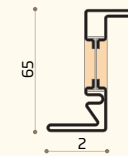

P.2805

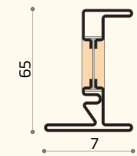

P.2815

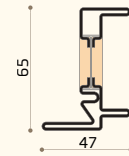

P.2822

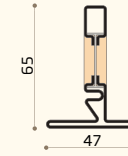

P.2832

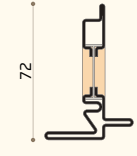

P.2833

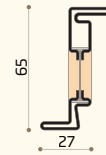

P.2842

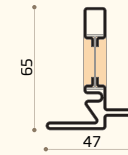

P.2843

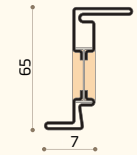

P.2871

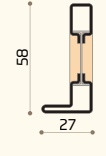

P.2872

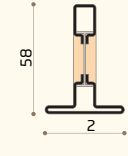

P.2873

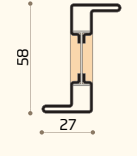

P.2874

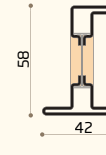

P.2875

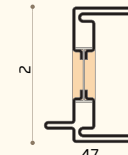

P.2892

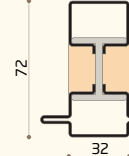

P.2893

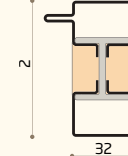

P.2895

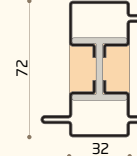

P.2654

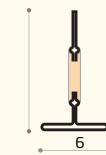

P.2664

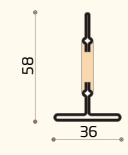

P.2606

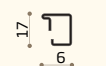

P.2607



P.2627



P.2629

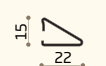

PA 2607



PA 2608

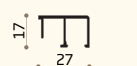

vertical section

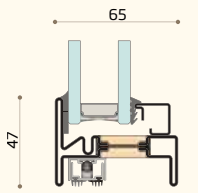
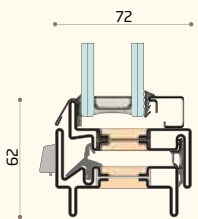
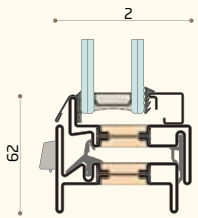
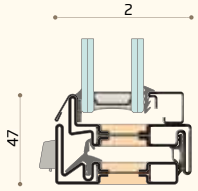

horizontal section

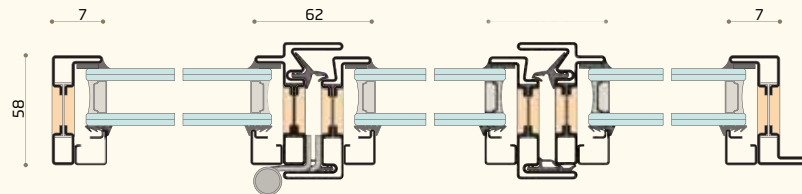
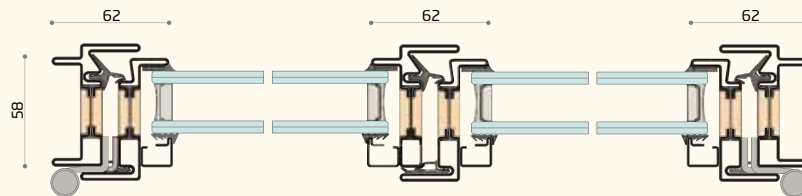
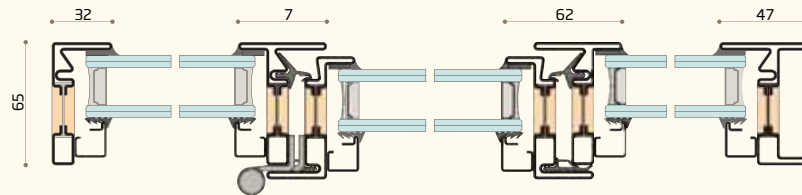
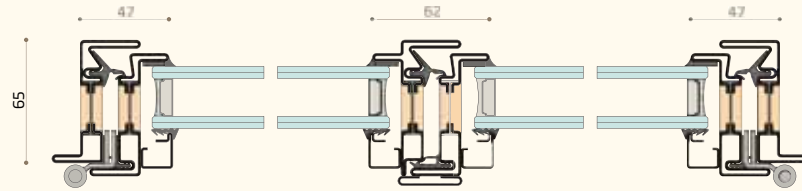

OS2 outward opening

main sections

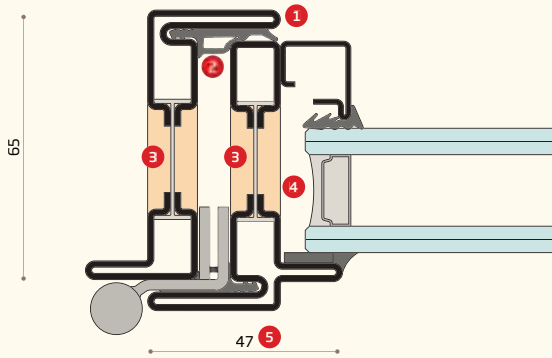

1. internal and external rebate
2. double rebate seal
3. structural thermal break in polyamide and polyurethane
4. fitting groove for glazing up to 30 mm thick
5. section with reduced size

profiles

P.2851

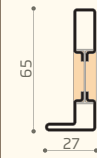

P.2852

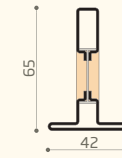

P.2853

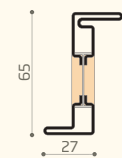

P.2855

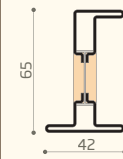

P.2861

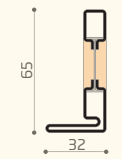

P.2862

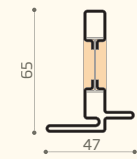

P.2863

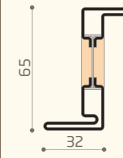

P.2865

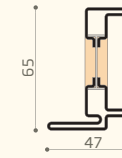

P.2872

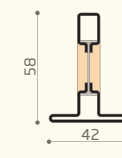

P.2873

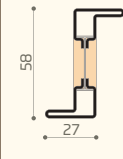

P.2875

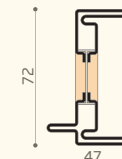

P.2882

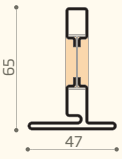

P.2892

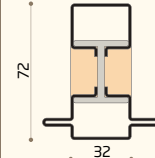

P.2893

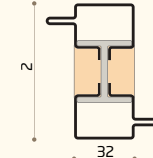

P.2895

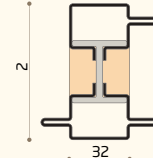

P.2652

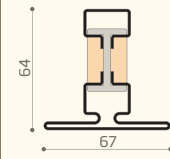

P.2654

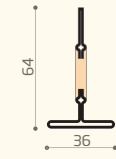

P.2655

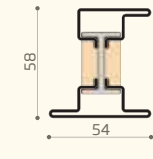

P.2664

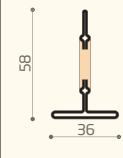

P.2606

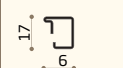

P.2607

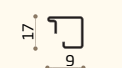

P.2627



P.2629



PA 2607

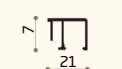

PA 2608

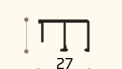

vertical section

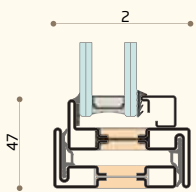
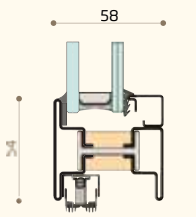
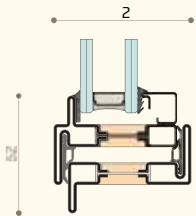
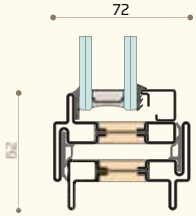

horizontal section

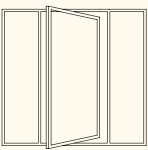
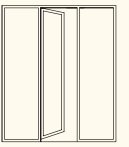
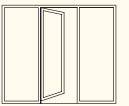
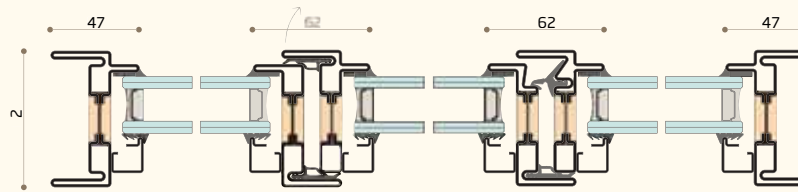
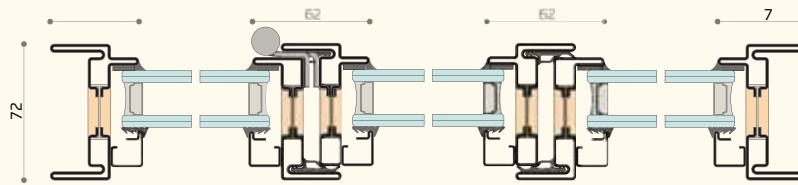
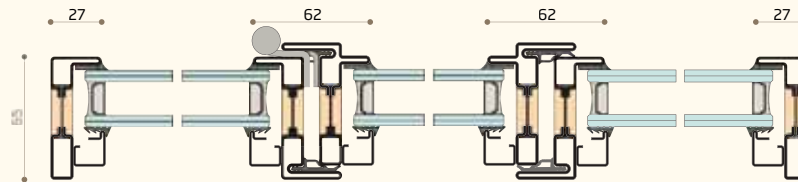
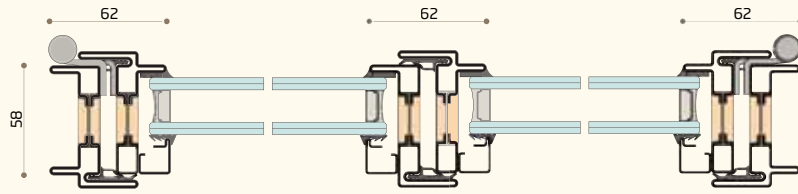

products comparison

p.30

OS2



p.56

EBE 65



p.70

EBE 85



p.82

EBE 85 AS



p.90

EBE Style



p.96

ML



p.100, p.108

termica e
termica UP



p.114

infinities HT



p.120

AF



p.130

blindacciaio



p.136

systemacciaio



p.148

security



products comparison: performance, heat flow, safety and face dimension

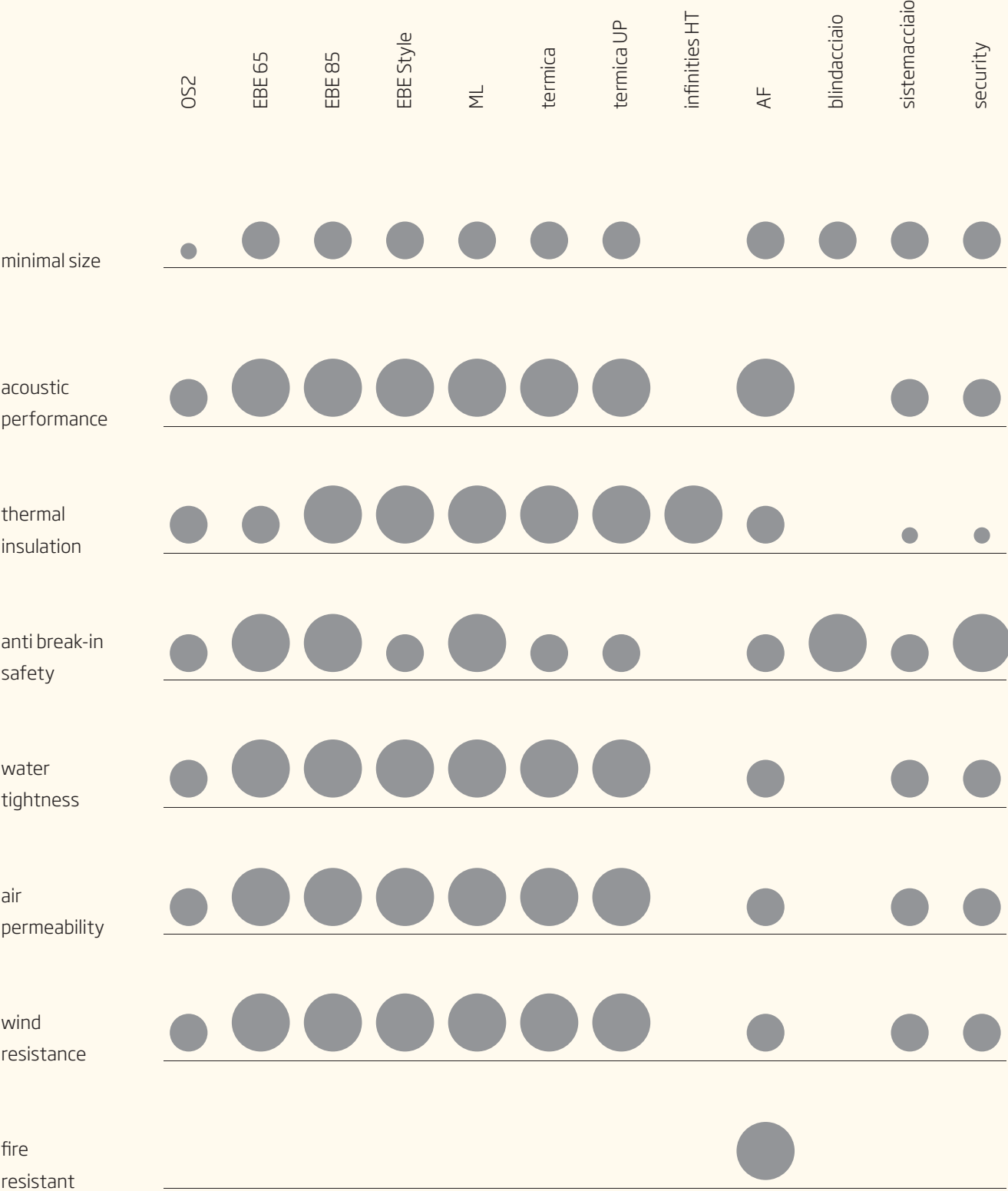

products comparison: design options

	OS2	EBE 65	EBE 85	EBE Style	ML	termica	termica UP	infinities HT	AF	blindacciaio	sistemacciaio	security
galvanized steel	●	●	●		●	●	●	●	●	●	●	●
stainless steel		●	●		●	●	●	●	●		●	
corten steel	●	●	●		●	●	●	●	●		●	
brass	●	●	●	●	●	●	●	●			●	
flush door/window		●	●	●					●	●	●	●
rebated door/window	●	●	●	●	●						●	●
concealed sashes			●									
concealed hinges for windows		●	●	●	●						●	●
concealed hinges for doors		●	●	●							●	●
concealed door closer			●	●							●	●

Secco Sistemi spa

via Terraglio 195

31022 Preganziol TV - Italy

tel. +39 0422 497700

fax +39 0422 497705

info@seccosistemi.it

www.seccosistemi.it

